

BS
AISI 316L

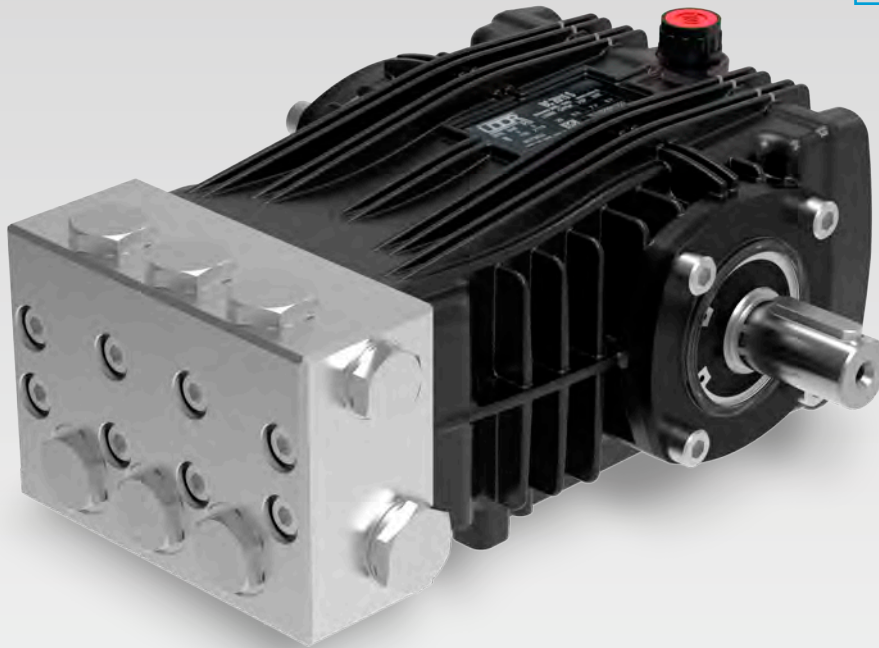

Tutti i modelli di Pompe della Serie BS sono disponibili con certificazione ATEX, su richiesta.

Upon request, all models of BS pumps series are available with ATEX certification



RPM	CODICE CODE	MODELLO MODEL	PORTATA FLOW		PRESSIONE PRESSURE		POTENZA POWER		PESO WEIGHT	PRESA DI FORZA SHAFT TYPE
			l/min	GPM	bar	PSI	HP	kW		
1450	730004	BSC 15/20 S	15.0	4.0	200	2900	7.7	5.7	10.6	S - Albero MASCHIO 24 mm DX S - MALE Shaft 24 mm RIGHT
	730003	BSC 18/20 S	18.5	4.9	200	2900	9.5	7.1	10.6	
	730002	BSC 21/20 S	21.0	5.5	200	2900	10.8	8.1	10.6	

Tutti i modelli di Pompe sono disponibili con Presa di Forza Sinistra. Nel Modello comparire "L". Esempio : MSC 16/20 S-L
All models of PUMPS are available with Left P.T.O. Shaft. Descriptions mention "L". For example : MSC 16/20 S-L

Dimensioni d'ingombro (mm) - Overall Dimensions (mm)

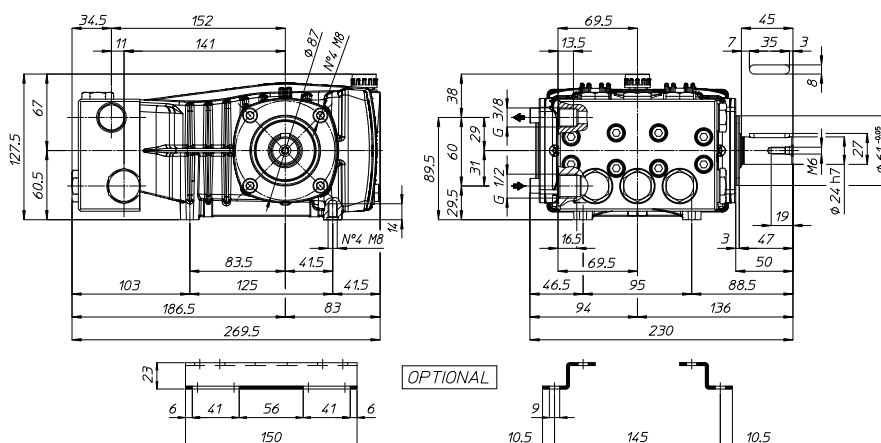

730004 - PUMP BSC 15/20 S

